

**GRAB RAILS
MODEL - CISCO 17"**

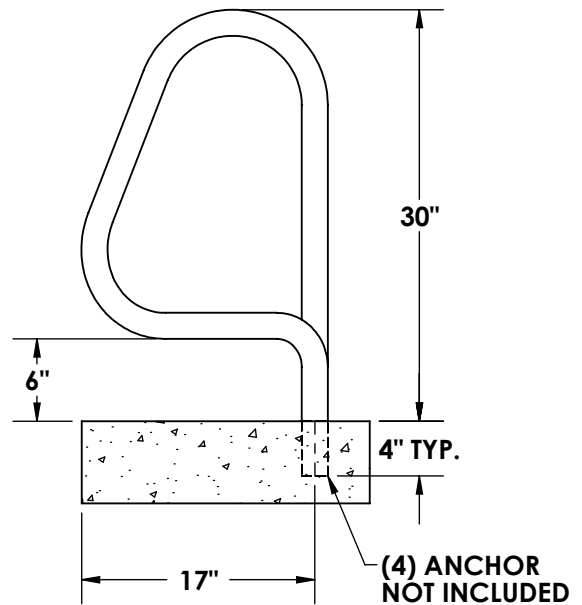
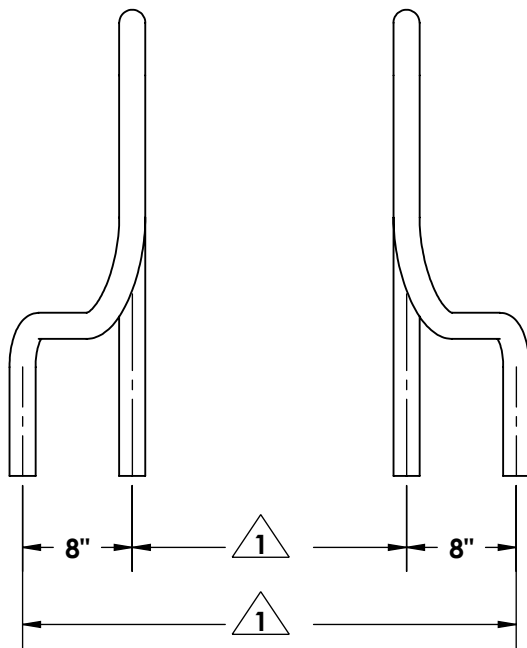
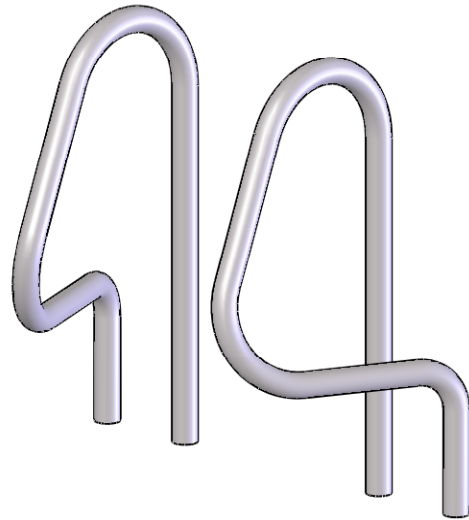

NOTE:

1 DIMENSIONS VARY WITH SPECIFIC APPLICATIONS.
SPECIFICATIONS ARE NOMINAL AND ARE SUBJECT TO CHANGE.
PLEASE CONTACT SPECTRUM AQUATICS FOR CUSTOM APPLICATIONS.

7100 Spectrum Lane
Missoula, Montana 59808
406.542.9781 * 800.791.8056
Fax: 406.542.1158
www.spectrumproducts.com

ENGINEERING DATA

PRODUCT:	CISCO 17"
PRODUCT #:	35117-.083
REVISION:	A
MATERIAL:	300 SERIES STAINLESS STEEL