

HANDRAILS
MODEL - 2 BEND STAIR RAIL 72"

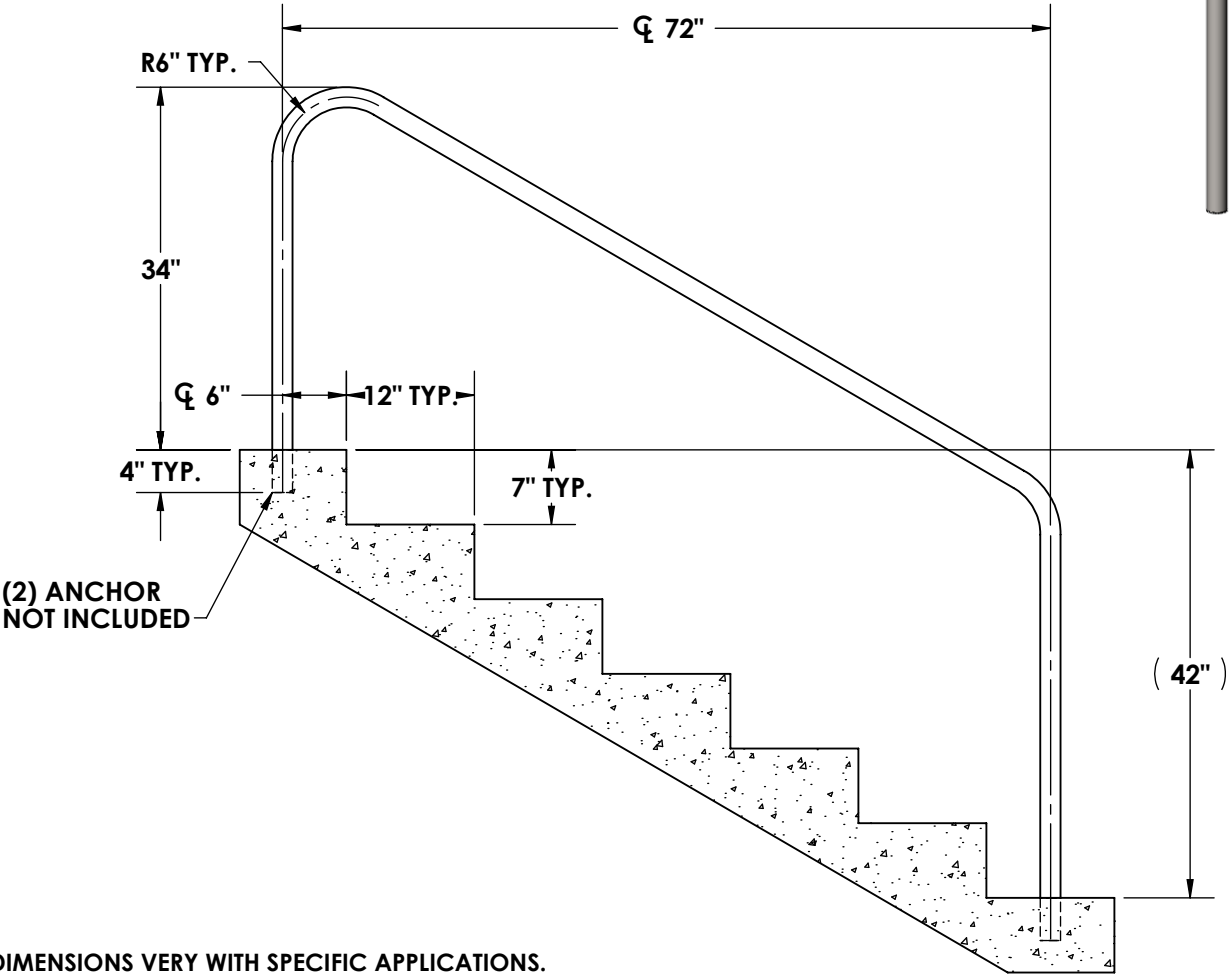

NOTE:
 1 **DIMENSIONS VARY WITH SPECIFIC APPLICATIONS.**
SPECIFICATIONS ARE NOMINAL AND ARE SUBJECT TO CHANGE.
PLEASE CONTACT SPECTUM AQUATICS FOR CUSTOM APPLICATIONS.

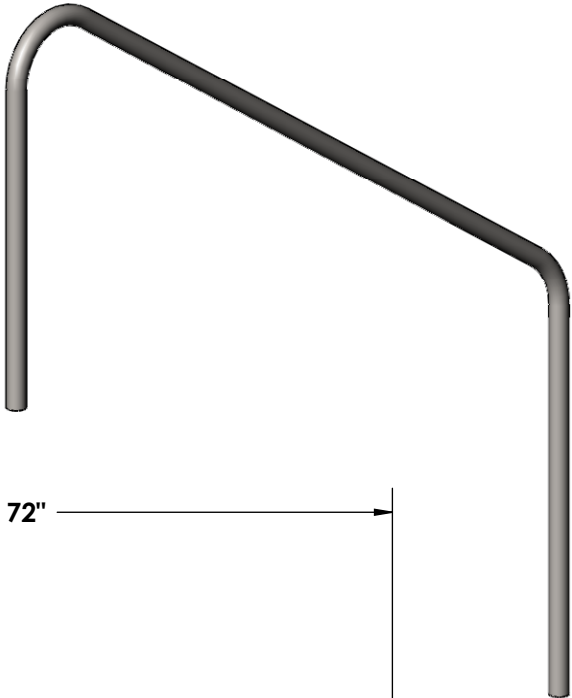

7100 Spectrum Lane
 Missoula, Montana 59808
 406.542.9781 * 800.791.8056
 Fax: 406.542.1158
 www.spectrumproducts.com

ENGINEERING DATA

PRODUCT:	2 BEND STAIR RAIL 72"
PRODUCT #:	35127-.109
REVISION:	A
MATERIAL:	300 SERIES STAINLESS STEEL